



# HOT DEALS

2024-2



EINFACH VIGOR.

Valid from 01/09/2024 to 28/02/2025 – errors excepted



HOT24-2/EN/XX/0



# In a class of its own!

**EXTRA DEEP!**

**EXTRA WIDE!**



Including socket strip with 2 x USB and 2 x USB-C as well as 2 metre H07 cable with safety plug

L x W x H  
1625 x 695 x 1017 mm

# 929

tools including tool trolley

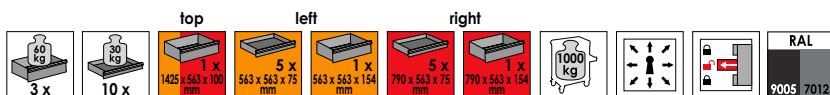

⑥







Discover a new dimension of reality!

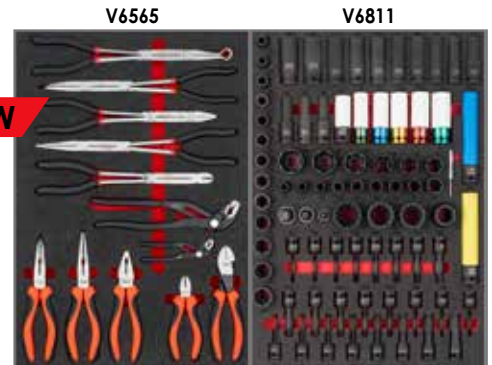
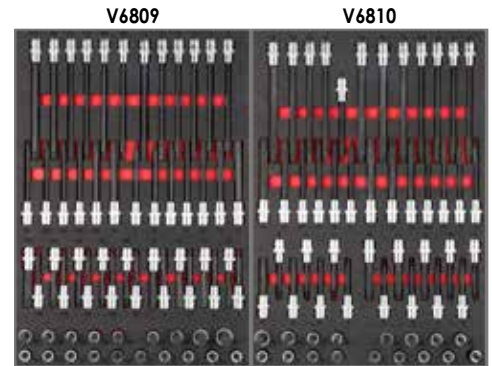
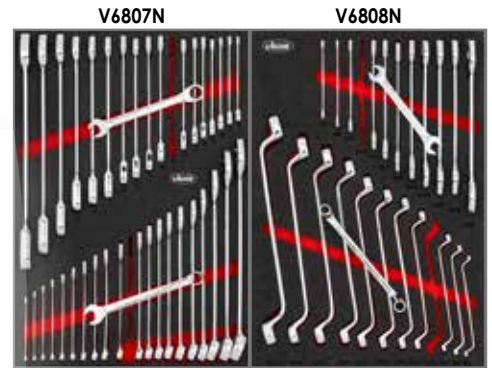
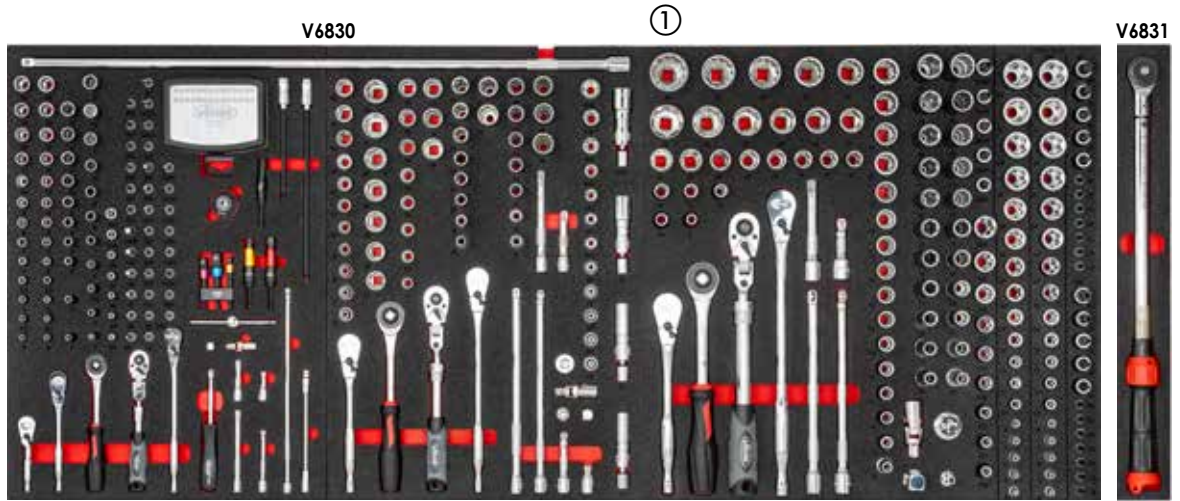

+ Including can holder V2398-XD



**NEW**

+929

Price including tool trolley



**VIGOR**  
**SERIES XD**

**EXTRA DEEP!**

# The space saver!

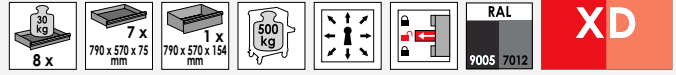

» With stainless steel worktop

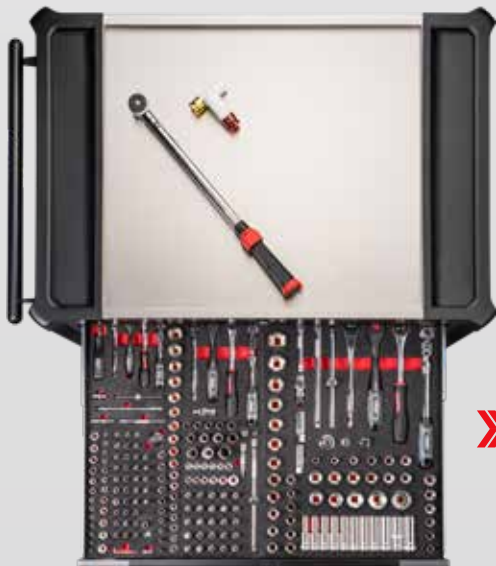

» **Drawer  
slide-out  
100%**





## ASSORTMENT 1 Including tool trolley with stainless steel worktop

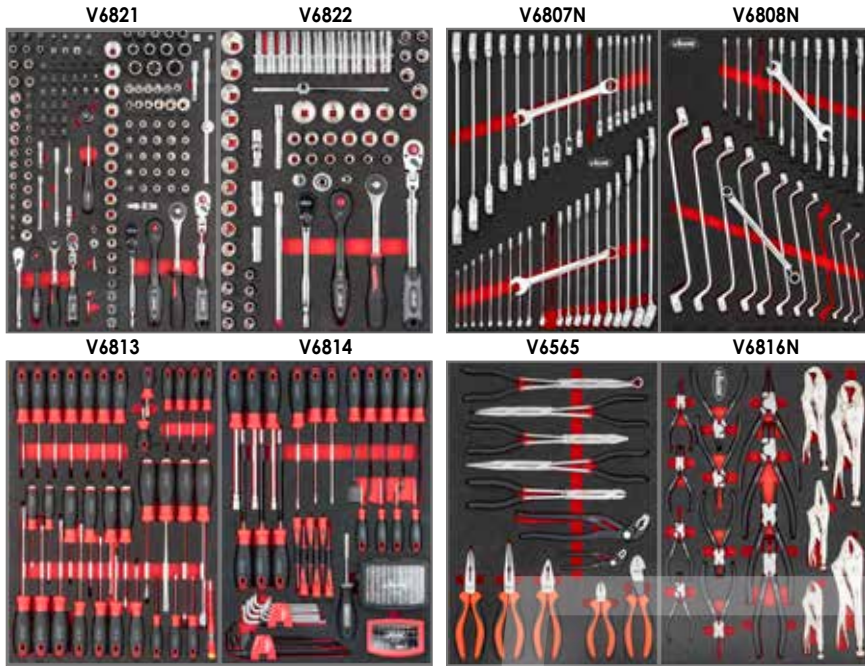

# 469

tools including tool trolley

VIGOR No.		Designation		EAN 4047728+
V4481-XD/469	469	Tool trolley with stainless steel worktop and assortment 1	190	068512

## ASSORTMENT 2 Including tool trolley with stainless steel worktop

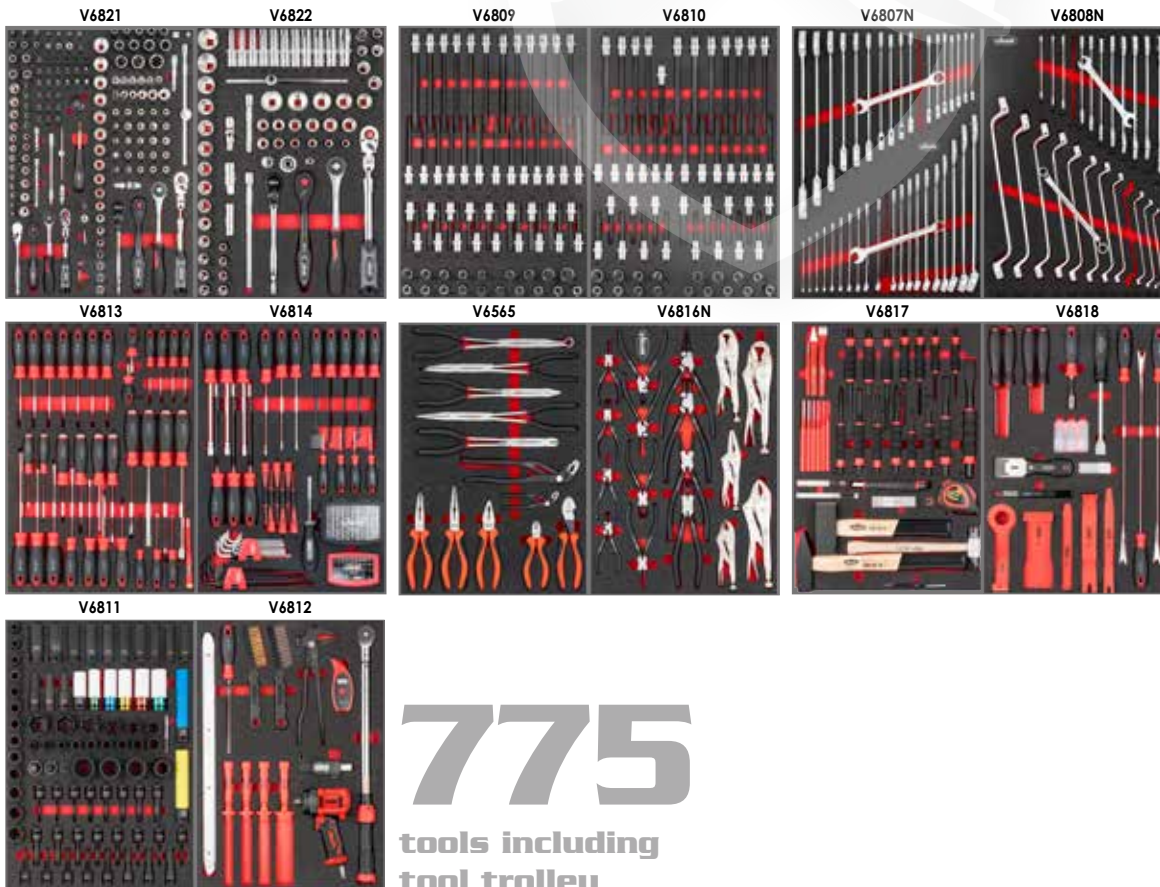

# 775

tools including tool trolley

VIGOR No.		Designation		EAN 4047728+
V4481-XD/775	775	Tool trolley with stainless steel worktop and assortment 2	210	068529



**VIGOR**  
**SERIES XL**



With stainless steel worktop

**Tool trolley available with assortment 1, 2 or 3!**



With plastic worktop

**Tool trolley available with assortment 1 or 3!**

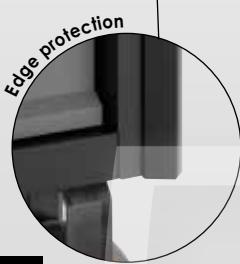

25 kg  
 8 x  
 753 x 398 x 75 mm  
 753 x 398 x 154 mm  
 1 x  
 500 kg  
 RAL 9005 7012  
**XL**

**ASSORTMENT 1** Including tool trolley with stainless steel or plastic worktop

**V4971N V4973N V4975N V7323**

**V4727 V5602 V5006 V5017 V5070 V5072**

**V6721N V6723N V4987 V6722N**

**V5170 V4729 V5075**

**V5633N V4995 V4999N V5004**

499

**tools including tool trolley**

VIGOR No.		Designation		EAN 4047728+
<b>V4481-X/499</b>	499	Tool trolley with stainless steel worktop and assortment 1	150	<b>062367</b>
<b>V5434</b>	499	Tool trolley with plastic worktop and assortment 1	141	<b>054348</b>



**ASSORTMENT 2** Including tool trolley with stainless steel worktop

V4586



V6650N

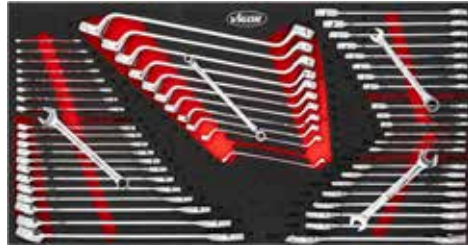

V7015N



V6015



V5170



**466**  
tools including  
tool trolley

VIGOR No.		Designation		EAN 4047728+
V4481-X/466	466	Tool trolley with stainless steel worktop and assortment 2	140	<b>074674</b>

**ASSORTMENT 3** Including tool trolley with stainless steel or plastic worktop

V4586



V6650N

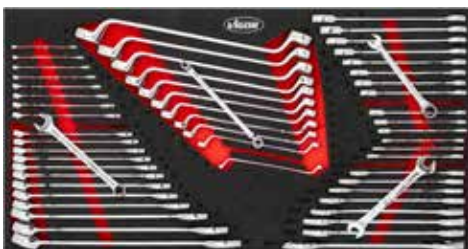

V5170



V5638N



**375**  
tools including  
tool trolley

VIGOR No.		Designation		EAN 4047728+
V4481-X/375	375	Tool trolley with stainless steel worktop and assortment 3	127	<b>062350</b>
V4542	375	Tool trolley with plastic worktop and assortment 3	117	<b>045421</b>



**VIGOR**  
**SERIES L**



With stainless steel worktop

**Tool trolley available with assortment 1, 2 or 3!**

Drawers:  
• 7x flat  
• 1x high



With plastic worktop

**Tool trolley available with assortment 2 or 3!**

Drawers:  
• 6x flat  
• 2x high

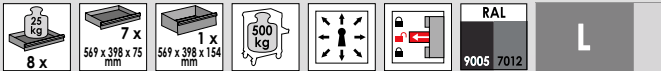

**ASSORTMENT 1** Including tool trolley with stainless steel worktop

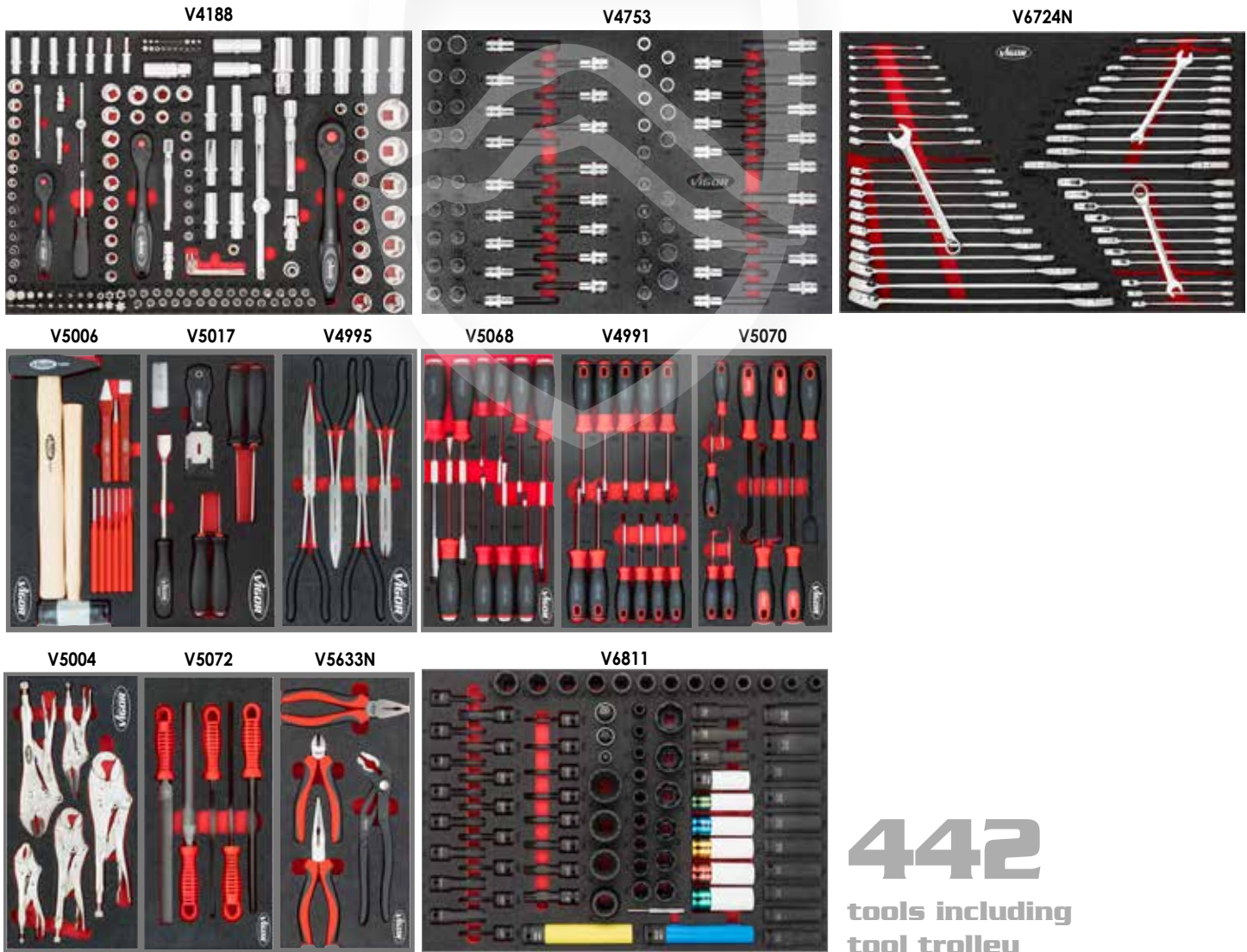

**442**  
tools including  
tool trolley

VIGOR No.	XX	Designation	kg	EAN 4047728+
V1901-X/442	442	Tool trolley with stainless steel worktop and assortment 1	131	084338



## ASSORTMENT 2 Including tool trolley with stainless steel or plastic worktop

V4188



V4753

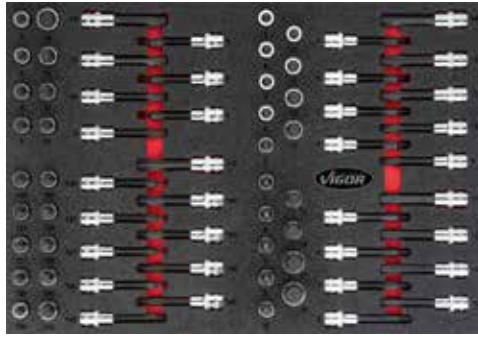

V6724N

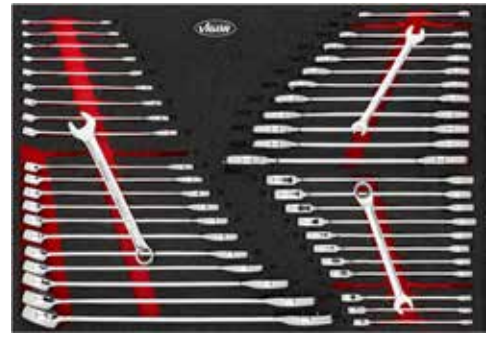

V5068

V5070

V5006



V5633N

V5603

V7324



# 376

tools including  
tool trolley

VIGOR No.		Designation		EAN 4047728+
V1901-X/376	376	Tool trolley with stainless steel worktop and assortment 2	119	084192
V1901/376	376	Tool trolley with plastic worktop and assortment 2	100	080293

## ASSORTMENT 3 Including tool trolley with stainless steel or plastic worktop

V4188

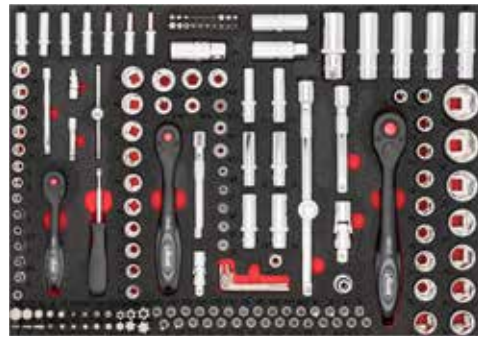

V6643N

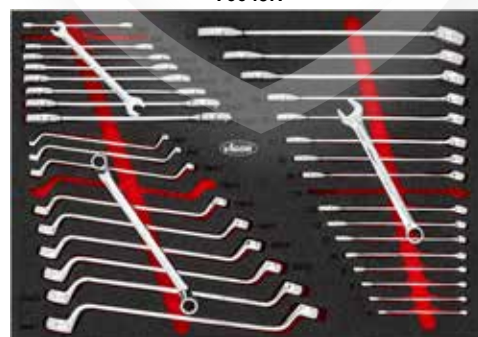

V4230



V5637N



V2837

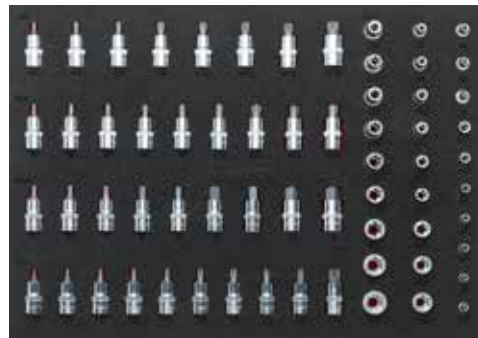

# 344

tools including  
tool trolley

VIGOR No.		Designation		EAN 4047728+
V4560-X	344	Tool trolley with stainless steel worktop and assortment 3	107	084178
V4560	344	Tool trolley with plastic worktop and assortment 3	95	045605





With mat

**Tool trolley available with assortment 1 or 2!**

- Drawers:**
- 5x flat
  - 2x high



**ASSORTMENT 1** Including tool trolley with mat



V5116

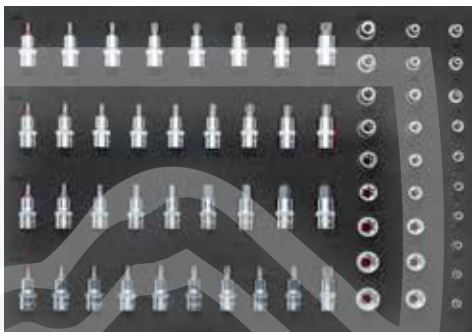

V2837

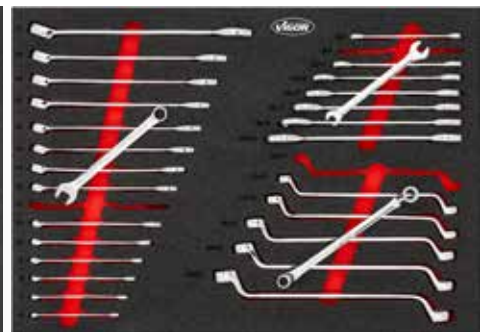

V6726N



V5111N

**320**  
tools including  
tool trolley

VIGOR No.		Designation		EAN 4047728+
V2712N	320	Tool trolley with mat and assortment 1	77	055451

**ASSORTMENT 2** Including tool trolley with mat



V5116



V5111N

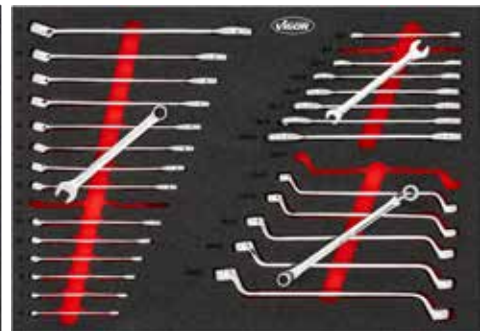

V6726N

**256**  
tools including  
tool trolley

VIGOR No.		Designation		EAN 4047728+
V2379N	256	Tool trolley with mat and assortment 2	72	055444



## V4481-XXL

EAN 4047728080491

### Extra deep tool trolley

- Without assortment, with stainless steel worktop
- Tool trolley details on page 2
- L x W x H: 1625 x 695 x 1017 mm

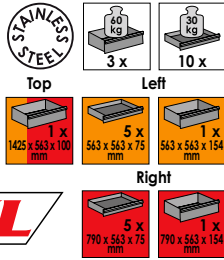

**VIGOR SERIES XXL**

## V4481-XD

EAN 4047728066488

### Extra deep tool trolley

- Without assortment, with stainless steel worktop
- L x W x H: 986 x 695 x 1017 mm

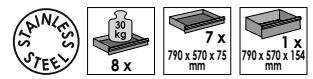

**VIGOR SERIES XD**

## V4481-X

EAN 4047728060721

### Tool trolley

- Without assortment, with stainless steel worktop
- L x W x H: 1017 x 940 x 514 mm

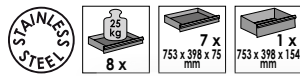

**VIGOR SERIES XL**

## V4481

EAN 4047728044813

### Tool trolley

- Without assortment, with plastic worktop
- L x W x H: 1017 x 940 x 514 mm

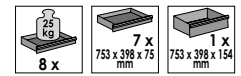

**VIGOR SERIES XL**

## V1901-X

EAN 4047728083072

### Tool trolley

- Without assortment, with stainless steel worktop
- L x W x H: 756 x 481 x 1002 mm

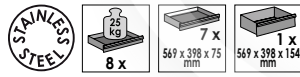

**VIGOR SERIES L**

## V1901

EAN 4047728019019

### Tool trolley

- Without assortment, with plastic worktop
- L x W x H: 756 x 481 x 1002 mm



**VIGOR SERIES L**

## V5489

EAN 4047728054898

### Tool trolley

- Without assortment, with foam mat
- L x W x H: 681 x 460 x 1016 mm

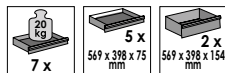

**VIGOR SERIES M**

## V4758

EAN 4047728047586

### Service trolley

- Loading capacity per tray: 40 kg
- Weight: 19 kg
- L x W x H: 763 x 443 x 845 mm

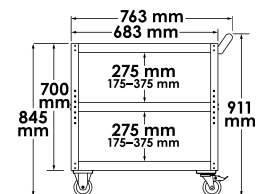

**V6399**

EAN 4047728085533

## Perforated tool panel plate for tool trolleys · Series L and XL

- Enables flexible and customised arrangement of tools and accessories by using tool hooks, holders, etc.
- Attachment via existing screw sleeves on VIGOR tool trolleys Series L and Series XL

**New**

**VIGOR SERIES L**

**VIGOR SERIES XL**

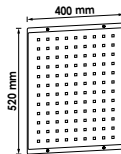

**V6399-XD**

EAN 4047728085540

## Perforated tool panel plate for tool trolleys · Series XD and XXL

- Enables flexible and customised arrangement of tools and accessories by using tool hooks, holders, etc.
- Attachment via existing screw sleeves on VIGOR tool trolleys Series XD and Series XXL

**New**

**VIGOR SERIES XD**

**VIGOR SERIES XXL**

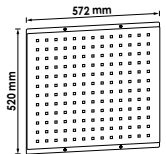

**V6150N**

EAN 4047728084734

## Multifunction vice · 360° rotatable

- Rotatable in horizontal and vertical axis
- Collet chucks for flat and round parts (drive shafts, steering tie rods, etc.)
- Flexible working from different angles
- Quick and easy adjustment of the working position
- Scales for clamping length (mm) and clamping angle (°)
- Hardened gripping jaws for maximum durability
- 125 mm collet chuck
- 130 mm max. span width



**New**



## NITRILE GLOVES

### Protect hands from oil, grease, chemicals and dirt

- Surface structure provides good adhesion, even in oily working conditions
- Safety colour orange for better visibility in dark work spaces
- Comfortable, tear-resistant glove with good dexterity
- Touchscreen compatible
- Material: nitrile
- Latex- and powder free

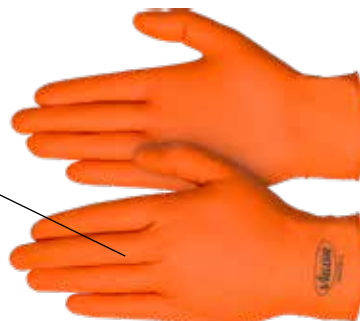
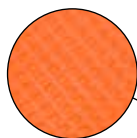

VIGOR No.		Size	EAN 4047728+
<b>V6436-M</b>		M	<b>080118</b>
<b>V6436-L</b>		L	<b>077712</b>
<b>V6436-XL</b>		XL	<b>077729</b>
<b>V6436-XXL</b>		XXL	<b>077736</b>



**V6000-059**

EAN 4047728085557

**Cordless tool holder**

- Holds 2 cordless tools
- Upper area offers space for chargers and additional batteries
- Simple hanging on 9 x 9 mm perforated tool panel grid

**New**

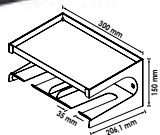

**V6000-060**

EAN 4047728085526

**Glove box holder**

- Ideal together with VIGOR Grip nitrile gloves
- Direct and ergonomic access thanks to easy removal
- Can be attached to all VIGOR tool trolleys and to 9 x 9 mm perforated tool panel grids
- Inside dimensions 250 x 112 x 123 mm

**New**

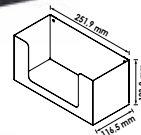

**V6396**

EAN 4047728069601

**Screwdriver holder**

- Quick access to screwdrivers directly on the tool trolley
- Suitable for all series
- For 12 screwdrivers



**V6221**

EAN 4047728062213

**Laptop table**

- Additional storage space for laptops, tablets, tools or motor vehicle components
- Suitable for all series
- Can be expanded and collapsed when installed
- Locking element prevents unintentional folding of the table
- Maximum permitted loading capacity: 25 kg

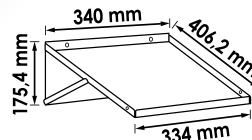

**V6397**

EAN 4047728069793

**Holder for paper reel · pivoting**

- Paper reels can be hung directly at the workplace
- Suitable for all series
- Paper reel not included
- Maximum width of paper reel: 320 mm



**V6395**

EAN 4047728070522

**Waste bin**

- Disposal of waste or cloths
- Suitable for all series
- Also suitable for storing tools
- Capacity: 20 l

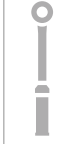
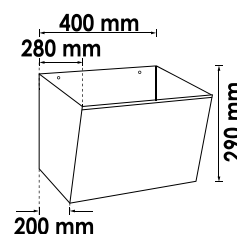

**V6000-056XL**

EAN 4047728084215

**Integrated refrigerator**

- Generous capacity: Sufficient space for up to 220 330 ml beverage cans (186 litres total volume)
- Temperature adjustable from 0 – 10 °C
- LED interior lighting can be switched off
- Including base frame for effortless integration into the storage system

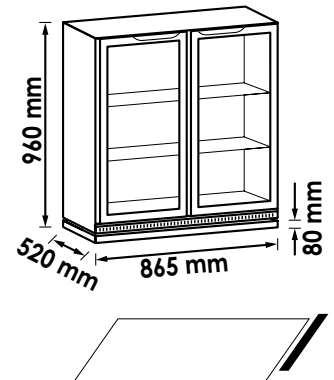
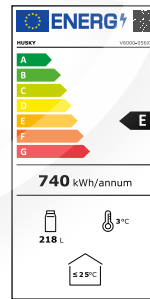

**V6000-058**

EAN 4047728083416

**Corner wall cabinet**

- Can be retrofitted into existing systems
- For 500 mm deep corner configurations
- Optimal storage of tools or consumables

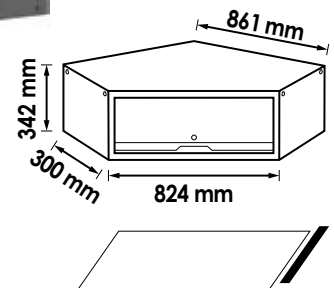



**V6000-03D**

EAN 4047728084369

## High cabinet with single-hinged door · extra deep

- Storage of tool boxes, work clothes, containers or motor vehicle parts
- Cabinet door with magnetic lock
- Height-adjustable storage compartment
- Inside dimensions: 526 x 677 mm
- Cabinet door can be fitted on the right and left

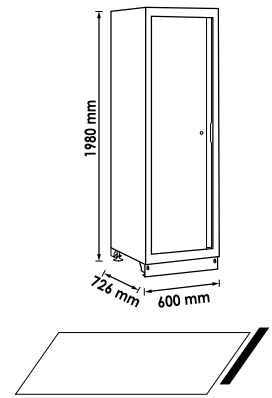

**V6000-03XD**

EAN 4047728084352

## High cabinet with double-hinged door · extra deep

- Storage of tool boxes, work clothes, containers or motor vehicle parts
- Cabinet door with magnetic lock
- Height-adjustable storage compartment
- Inside dimensions: 1,047 x 677 mm

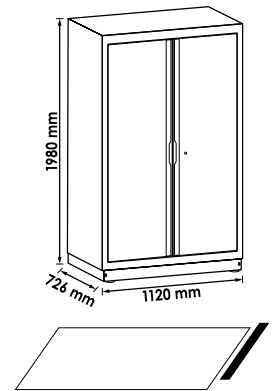

**V2414N**

EAN 4047728056434

**1/4" socket set**

• For manual operation

- 
- 4 · 4.5 · 5 · 5.5 · 6 · 7 · 8 · 9 · 10 · 11 · 12 · 13 · 14 mm
- 
- 3 · 4 · 5 · 6 · 7 · 8 mm
- 
- 0.8x4 · 1x5 · 1.2x6.5 · 1.2x7 mm
- 
- PH 1 · PH 2 · PH 3
- 
- PZ 1 · PZ 2 · PZ 3
- 
- T 10 · T 15 · T 20 · T 25 · T 30 · T 40
- 
- 150 mm



46

**V3734N**

EAN 4047728056427

**1/4" socket set**

• For manual operation

- 
- 4 · 4.5 · 5 · 5.5 · 6 · 7 · 8 · 9 · 10 · 11 · 12 · 13 mm
- 
- PH 1 · PH 2
- 
- PZ 1 · PZ 2
- 
- T 15 · T 20 · T 25 · T 30
- 
- 150 mm



23

**V2305N**

EAN 4047728056441

**3/8" socket set**

• For manual operation

- 
- 6 · 7 · 8 · 9 · 11 · 12 · 13 · 14 · 15 · 16 · 17 · 18 · 19 · 20 · 21 · 22 · 24 mm
- 
- 8 · 9 · 10 · 11 · 12 · 13 · 14 · 15 · 17 · 19 mm
- 
- 3 · 4 · 5 · 6 · 7 · 8 · 10 mm
- 
- 0.8x5.5 · 1x7 · 1.2x8 mm
- 
- PH 1 · PH 2 · PH 3
- 
- PZ 1 · PZ 2 · PZ 3
- 
- T 15 · T 20 · T 25 · T 27 · T 30 · T 40 · T 45 · T 50 · T 55
- 
- 200 mm



61



**V2461N**

EAN 4047728056472

**Socket set**

• For manual operation

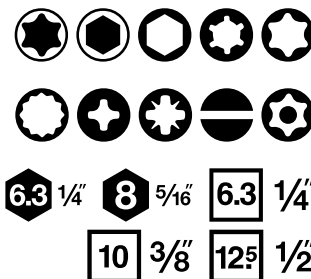

- 4 · 4.5 · 5 · 5.5 · 6 · 7 · 8 · 9 · 10 · 11 · 12 · 13 · 14 mm
- 4 · 5 · 6 · 7 · 8 · 9 · 10 mm
- E 4 · E 5 · E 6 · E 7 · E 8
- 3 · 4 · 5 · 6 mm
- 0.8x4 · 1x5 · 1.2x6.5 · 1.2x7 mm
- PH 0 · PH 1 · PH 2
- PZ 0 · PZ 1 · PZ 2
- T 8 · T 9 · T 10 · T 15 · T 20 · T 25 · T 27 · T 30
- T 8 H · T 9 H · T 10 H · T 15 H · T 20 H · T 25 H · T 27 H · T 30 H
- 150 mm
- 10 · 11 · 12 · 13 · 14 · 15 · 16 · 17 · 18 · 19 mm
- 10 · 11 · 12 · 13 · 14 · 15 mm
- E 10 · E 11 · E 12 · E 14 · E 16 · E 18
- 200 mm
- 10 · 11 · 12 · 13 · 14 · 15 · 16 · 17 · 18 · 19 · 20 · 21 · 22 · 24 · 27 · 30 · 32 mm
- 16 · 17 · 18 · 19 · 22 mm
- E 20 · E 24
- 250 mm

6.3 1/4 8 5/16 6.3 1/4  
10 3/8 12.5 1/2

172

**V3277N**

EAN 4047728056489

**Socket set**

• For manual operation

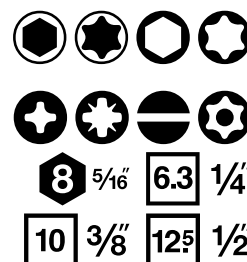

- 4 · 4.5 · 5 · 5.5 · 6 · 7 · 8 · 9 · 10 · 11 · 12 · 13 · 14 mm
- 4 · 5 · 6 · 7 · 8 · 9 · 10 mm
- E 4 · E 5 · E 6 · E 7 · E 8
- 150 mm
- 10 · 11 · 12 · 13 · 14 · 15 · 16 · 17 · 18 · 19 mm
- 10 · 11 · 12 · 13 · 14 · 15 mm
- E 10 · E 11 · E 12 · E 14 · E 16 · E 18
- 198 mm
- 13 · 14 · 15 · 16 · 17 · 18 · 19 · 20 · 21 · 22 · 24 · 27 · 30 · 32 mm
- 16 · 17 · 18 · 19 · 22 mm
- E 20 · E 22 · E 24
- 250 mm
- 8 · 9 · 10 · 11 · 12 · 13 · 14 · 15 · 17 · 19 · 22 · 24 mm

8 5/16 6.3 1/4  
10 3/8 12.5 1/2

212

**V4425N**

EAN 4047728058919

**Socket set**

• For manual operation

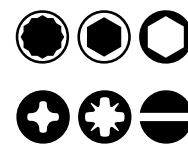

- 4 · 4.5 · 5 · 5.5 · 6 · 7 · 8 · 9 · 10 · 11 · 12 · 13 mm
- 3 · 4 · 5 · 6 mm
- 0.8x4 · 1x5.5 · 1.2x6.5 mm
- PH 1 · PH 2 · PH 3
- PZ 1 · PZ 2 · PZ 3
- T 10 · T 15 · T 20 · T 25 · T 30 · T 40
- 150 mm
- 10 · 11 · 12 · 13 · 14 · 15 · 16 · 17 · 19 · 20 · 21 · 22 · 24 · 27 · 30 · 32 mm
- 250 mm
- 8 · 9 · 10 · 11 · 12 · 13 · 14 · 15 · 16 · 17 · 18 · 19 mm

6.3 1/4 12.5 1/2

95



**V2318N**

EAN 4047728059299

**3/4" socket set**

• For manual operation

**20** 3/4"



- 19 · 21 · 22 · 23 · 24 · 26 · 27 · 28 · 30
- 32 · 34 · 36 · 38 · 41 · 46 · 50 mm
- 500 mm



**21**

**V1781N**

EAN 4047728085182

**T socket set**

• For manual operation

**New**



- 6.3** 1/4"
- 10** 3/8"
- 12.5** 1/2"



- 1/4" E 4 · E 5 · E 6 · E 7 · E 8
- T 27
- 1/4" T 9 H · T 10 H · T 15 H · T 25 H · T 30 H
- 3/8" E 10 · E 12 · E 14 · E 16
- 1/2" T 40 · T 45 · T 47 · T 50
- 1/2" T 45 H · T 50 H
- 1/2" E 18 · E 20
- 1/2" T 55 · T 60
- 1/2" T 55 H

**34**

**V2687N**

EAN 4047728084376

**T socket set**

• For manual operation

**New**



- 6.3** 1/4"
- 10** 3/8"
- 12.5** 1/2"



- 1/4" E 4 · E 5 · E 6 · E 7 · E 8 · E 10 · E 11
- 3/8" E 4 · E 5 · E 6 · E 7 · E 8 · E 10 · E 11 · E 12 · E 14 · E 16 · E 18 · E 20
- 1/2" E 10 · E 11 · E 12 · E 14 · E 16 · E 18 · E 20 · E 22 · E 24

**28**

**V7014**

EAN 4047728083447

**T socket set · long**

• Longer T-sockets for greater flexibility and reach when working in hard-to-reach places  
• For manual operation

**6.3** 1/4" **10** 3/8" **12.5** 1/2"

**New**

- 1/4" E 4 · E 5 · E 6 · E 7 · E 8
- 3/8" E 10 · E 12 · E 14 · E 16
- 1/2" E 18 · E 20 · E 22 · E 24



**14**



V7920N

EAN 4047728081702

**T-plus socket set**

- T-plus profiles are installed in BMW · VAG · MERCEDES-BENZ · AUDI · MAN · FORD · OPEL · MAZDA · TOYOTA · TESLA · NISSAN · RENAULT · SUBARU · GM · CHEVROLET
- IP: wheel bearing · engine · gearbox · cam adjuster · flywheel · timing belt housing · seat belt anchorages
- IPR: engine · control unit · generators · side mirrors · plug-in pumps · air flow meters
- EP: gearbox · clutch disc and flywheel · crankshaft bolt · exhaust nuts · engine mount
- EPR: interior trim · door handles · rear lights · headlights · electrical connections · bumper beams · suspension parts · brakes



6.3 1/4" 10 3/8" 12.5 1/2"



T-profile



T-plus profile

**Now with even more special profiles!**

IP



IPR



EP



EPR



Size	
6.3 1/4"	IP8 · IP10 · IP15 · IP20 · IP25 · IP27 · IP30
	IP40 · IP45 · IP50 · IP55 · IP60
12.5 1/2"	IPR8 · IPR10 · IPR15 · IPR20 · IPR25 · IPR27 · IPR30
	IPR40 · IPR45 · IPR50 · IPR55 · IPR60
6.3 1/4"	EP4 · EP5 · EP6 · EP7 · EP8
	EP10 · EP11 · EP12 · EP14 · EP16
10 3/8"	EP18 · EP20 · EP22 · EP24 · EP26 · EP28 · EP30 · EP32
	EP18 · EP20 · EP22 · EP24 · EP26 · EP28 · EP30 · EP32
6.3 1/4"	EPR4 · EPR5 · EPR6 · EPR7 · EPR8
	EPR10 · EPR11 · EPR12 · EPR14 · EPR16
10 3/8"	EPR18 · EPR20 · EPR22 · EPR24 · EPR26 · EPR28 · EPR30 · EPR32
	EPR18 · EPR20 · EPR22 · EPR24 · EPR26 · EPR28 · EPR30 · EPR32

60



V5461

EAN 4047728080323

**Socket set**

- For manual operation



**12-point design**



6.3 1/4" 10 3/8" 12.5 1/2"



➤ **For components see catalogue page 175**

133



**V7740/15**

EAN 4047728084147

**Combination wrench set**

- Chrome-vanadium
- DIN 3113
- Surface: chrome-plated, polished



**New**

6 · 7 · 8 · 9 · 10 · 11 · 12 · 13 · 14 · 15 · 16 · 17 · 18 · 19 · 22 mm



15

**V7740/22**

EAN 4047728084130

**Combination wrench set**

- Chrome-vanadium
- DIN 3113
- Surface: chrome-plated, polished



**New**

6 · 7 · 8 · 9 · 10 · 11 · 12 · 13 · 14 · 15 · 16 · 17 · 18 · 19 · 20 · 21 · 22 · 24 · 27 · 30 · 32 · 36 mm



22

**V7730/12**

EAN 4047728084161

**Double open-end wrench set**

- Chrome-vanadium
- DIN 3113
- Surface: chrome-plated, polished



**New**

6 x 7 · 8 x 9 · 10 x 11 · 12 x 13 · 14 x 15 · 16 x 17 · 18 x 19 · 20 x 22 · 21 x 23 · 24 x 27 · 25 x 28 · 30 x 32 mm



12

**V7750/12**

EAN 4047728084154

**Double box-end wrench set**

- Chrome-vanadium
- DIN 3113
- Surface: chrome-plated, polished



**New**

6 x 7 · 8 x 9 · 10 x 11 · 12 x 13 · 14 x 15 · 16 x 17 · 18 x 19 · 20 x 22 · 21 x 23 · 24 x 27 · 25 x 28 · 30 x 32 mm



12



**V7740/6**

EAN 4047728**084499**

**Combination wrench set XXL**

- Chrome-vanadium
- DIN 3113
- Surface: chrome-plated, polished



**New**

● ● ● ● ● ● 34 · 36 · 38 · 41 · 46 · 50 mm



6

**V6640**

EAN 4047728**085588**

**Combination wrench set XXL  
soft foam insert**

- Set contents V7740/6

L

**New**



6

**V7031**

EAN 4047728**082624**

**Ratcheting box-end wrench set · extra long**

- At least 60 % longer than standard ratchet wrenches – for greater power transmission
- Slim design
- Tool roll
- Surface chrome-plated, polished
- 72 teeth
- 5° operating angle



● ● ● ● ● ● 10 · 11 · 12 · 13 · 14 · 15 · 16 · 17 · 18 · 19 mm



10

**V1031**

EAN 4047728**010313**

**Ratcheting combination wrench set · long**

- Tool roll
- Surface: chrome-plated, polished
- 72 teeth
- 5° operating angle



● ● ● ● ● ● 8 · 9 · 10 · 11 · 12 · 13 · 14 · 15 · 16 · 17 · 18 · 19 mm



12



## MACHINIST'S HAMMER

- Hickory wood handle
- High-quality hammer with rubber impact protection
- Robust construction for long-lasting performance and reliability

**New**



VIGOR No.	Length mm	⚖️ g	EAN 4047728+
<b>V2662-300</b>	300	300	<b>084444</b>
<b>V2662-500</b>	320	500	<b>084451</b>
<b>V2662-800</b>	350	800	<b>084437</b>
<b>V2662-1000</b>	360	1000	<b>084420</b>

**V2663-1500**

EAN 4047728084383

### Club hammer

- Hickory wood handle
- High-quality hammer with rubber impact protection

**New**



**V5681**

EAN 4047728056816

### Electronic diagonal cutter

- For wire classes:
  - Soft to Ø 1.6 mm
  - Medium-hard to Ø 1.2 mm
  - Hard to Ø 0.8 mm

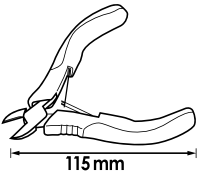

**V6500-190**

EAN 4047728084208

### Heavy-duty diagonal cutter

- High-performance power side cutter for precise and effortless cutting
- Robust construction and sharp cutting blades for clean and precise cuts
- Ergonomically shaped handles for maximum comfort and control during use

**New**

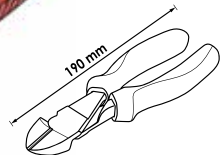

**V6504-125**

EAN 4047728082617

### Universal pliers with pushbutton · 125 mm

- Adjustment of the jaw opening at the touch of a button
- Locking of the hinge pin prevents unintentional adjustment
- Jaw opening: up to 44 mm
- Capacity for nuts, size 27 mm
- Capacity for pipes Ø 29 mm / Ø 1"
- Adjustment positions: 15
- Weight: 89 g

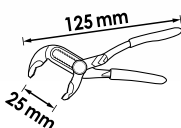

**V6504-250**

EAN 4047728077750

### Universal pliers with pushbutton · 250 mm

- Adjustment of the jaw opening at the touch of a button
- Locking of the hinge pin prevents unintentional adjustment
- Jaw opening: up to 65 mm
- Capacity for nuts, size 46 mm
- Capacity for pipes Ø 50 mm · Ø 2"
- Adjustment positions: 23

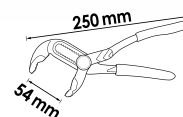



# PIPE WRENCHES

- Robust cast iron pliers body enables high power transmission
- Quick canting and release on the workpiece due to internal spring
- Coarse jaw serration for optimum grip



- Jaw opening: up to 60 mm
- Capacity for pipes: Ø 2"

## HEAVY DUTY

Continuously adjustable



- Jaw opening: up to 88 mm
- Capacity for pipes: Ø 3"



VIGOR No.	Length mm	Weight kg	EAN 4047728+
<b>V5639</b>	350	1.3	<b>075589</b>
<b>V5639-24</b>	620	3.2	<b>081719</b>

### V4640

EAN 4047728**081726**

#### Hose clamp pliers

- For operating hose and spring band hose clamps
- Rotatable jaws for confined spaces
- Locking element for temporary holding of the clamp



### V4641

EAN 4047728**075558**

#### Clamp pliers

- Operation of stepless and earless clamps on axle boots
- Also suitable for thermoplastic axle boots



### V4637N

EAN 4047728**075565**

#### Hose and spring band clamp pliers

- For operating hose and spring band hose clamps
- Thanks to a flexible bowden cable perfect for hard-to-reach self-gripping hose and spring band hose clamps
- Bowden cable locking element facilitates temporary holding of the clamp
- Total length of bowden cable: 590 mm
- Clamping range: 18 – 53 mm



### V4737

EAN 4047728**075572**

#### Fuel line pliers

- Thanks to a flexible bowden cable perfect for hard-to-reach fuel couplings
- Total length of bowden cable: 590 mm
- Opening width: 30 mm



**V7524**

EAN 4047728081320

### Flue gas leakage tester

#### For leakage detection in closed systems

- Leaks are quickly visualised through the application of flue gas
- Operation via the 12 V on-board power supply
- Pressurisation by means of "Luft" (air) mode and integrated manometer possible without further aids
- Smoke generation with suitable aid (vegetable glycerine or baby care oil)
- Universal application option thanks to various adapters
- Built-in air compressor
- Automatic safety shutdown in case of imminent overheating
- Infinitely adjustable air flow

#### Diverse application possibilities, for example:

- Intake and boost pressure system
- Crankcase
- Exhaust gas and exhaust gas recirculation system
- Fuel system
- Adblue and additive system
- Tyres
- EVAP fuel system (US vehicles)
- Car body and glazing (wind noise, moisture penetration, etc.)



VIGOR No.	Designation	EAN 4047728+
<b>V7524-1</b>	Power cable	<b>081474</b>
<b>V7524-2</b>	Smoke hose	<b>081481</b>
<b>V7524-3</b>	Conical adapter	<b>081504</b>
<b>V7524-4</b>	Valve extractor	<b>081528</b>
<b>V7524-5</b>	Air bellows adapter	<b>081535</b>
<b>V7524-6</b>	Hard rubber plug	<b>081542</b>
<b>V7524-7</b>	Plug for small lines	<b>081559</b>
<b>V7524-8</b>	Cover caps, red	<b>081566</b>
<b>V7524-9</b>	EVAP connection adapter	<b>081573</b>



25

**V7524-10**

EAN 4047728084321

### Diagnostic liquid

- Ready-to-use diagnostic liquid for the generation of dense, white and odourless vapour in the Vigor V7524 flue gas leakage tester
- The liquid is non-toxic and biodegradable
- The quantity of 250 ml is sufficient for numerous applications



**The perfect solution for every diagnosis – 250 ml diagnostic liquid!**



**V4385N**

EAN 4047728072601

**Oil filling device with adapter set**

- Filling gearboxes and differentials with oil
- Incl. oil pan and 16 adapters for vehicles with limited installation space



18

**V7385**

EAN 4047728077194



**MERCEDES-BENZ 9G-Tronic gearbox tool set**

- Includes all necessary tools for changing the oil in the 9-speed Tronic automatic gearbox
- For draining and filling the gearbox oil
- For gearboxes with designation 725 (725589029000, 725589009000)
- Drain wrench for adjusting the standpipe

**Contents:**

- 1 x oil filter adapter
- 1 x multifunction oil drain wrench
- 1 x oil drain plug wrench



4

**V6027N**

EAN 4047728084505

**Oil filler tank set**

- Oil filler tank for various vehicle types
- Prevents oil from spilling
- Quick and uncomplicated filling of oil
- Reduces oil stains and dirt contamination in the engine compartment



**New**

**For all common vehicle models!**

16



**V4325**

EAN 4047728043250

### Vacuum and pressure pump set

- Testing pressure and underpressure systems
- Charging pressure
- Vacuum solenoids
- MAP sensors
- Tank aerations
- Brake line systems
- Including extensive assortment of adapters



**V1963/28**

EAN 4047728081467

### Cooling system diagnosis set

**New adapter series with approx. 20 % space saving per adapter!**

- Comfortable and efficient work, by reaching almost all expansion tanks
- Greatest market coverage
- Passenger car diagnostics
- Complete set for service work on the cooling system and heating circuit
- Comprehensive range of adapters for vehicles with water-cooled engines
- 3 features: pressure test (check for leaks in radiator system) · filling · cleaning
- Control of pressure loss via manometer
- Filling creates a vacuum in the radiator system (Advantage: coolant is sucked in without air bubbles)
- Enables filling of even large engines without thermal influences
- Universal usage due to conical rubber radiator adapter
- Measuring range: 0–2.5 bar



**New adapter series with approx. 20 % space saving per adapter!**

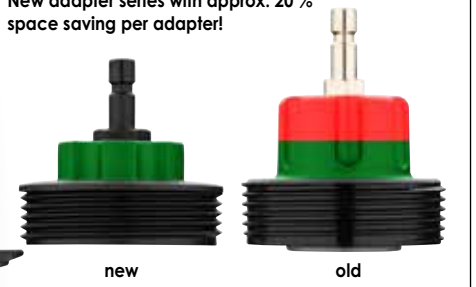

**» Largest model coverage on the market! Compatible with hybrid vehicles!**

28





V7471/17

EAN 4047728077187

**Brake bleeding complete set**

For bleeding brake line systems and changing brake fluids

- Also for bleeding coupling systems
- Easy opening and closing of the brake nipple thanks to special hinge ratchet
- Guarantees fast access to the brake nipple even with the wheel mounted
- Angle coupling piece in 90° design with back pressure valve and anti-rotation protection
- Socket inserts: sizes 7 – 12 mm in short and long designs included in delivery



Take a look!

17

V6917

EAN 4047728069175

**Brake line ratcheting tube cutter Ø 4.75 mm**

- Space saving, with ratchet mechanism
- Ratcheting mechanism in the head of the tool minimises space required – can be used directly on the vehicle
- No readjustment of the cutting wheel due to self-adjustment
- Faster cutting result than with conventional line cutters
- Adjustment of the self-adjusting cutting force possible
- Spare blades V6917-REP



V4416

EAN 4047728044165

**Tube flaring tool for Ø 4.75 mm brake lines**

- Exclusively for DIN flaring
- Exact positioning of the brake line in the device using a spacing adapter
- Application on brake and hydraulic lines directly on the vehicle
- For thin-walled pipes made of steel, aluminium and copper (metric / inch)
- No damage to coated lines
- For DIN "F" flares 180°



V1711N

EAN 4047728060738

**Brake piston readjusting tool set · pneumatic**

- Pushing and turning of brake pistons on nearly all passenger cars
- Efficient work on brake systems
- For clockwise and anti-clockwise brake pistons
- In addition to pneumatic support, controlled rewinding by hand is also possible



23



## V6312/12

EAN 4047728083423

### 1/2" impact socket set

- Damage-free operation of wheel bolts by rotating plastic sleeve
- Comprehensive set with all necessary nut-drivers
- For impact operation
- Sizes 15 + 17 + 18.5 + 19 + 19.5 + 20.5 + 21 + 21.5 + 22 + 22.2
- KIA, HYUNDAI and MERCEDES-BENZ special profiles

**New**



12<sup>5</sup> 1/2"



FORD

KIA

MERCEDES-BENZ

12

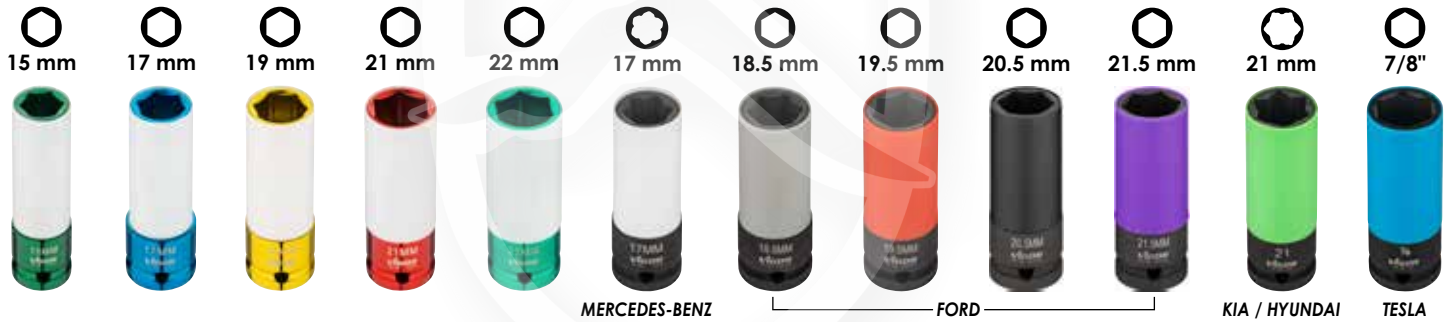

## V6309

EAN 4047728075534

### Impact socket set FORD

- Operation of damaged 19 mm wheel nuts
- 18.5 mm impact socket for wheel nuts with missing chrome cap
- 19.5 mm impact socket for wheel nuts with deformed chrome cap

12<sup>5</sup> 1/2"



For wheel nuts 21 mm



For wheel nuts 19 mm

## V6313

EAN 4047728083331

### Impact socket set

- Operation of damaged 21 mm wheel nuts
- 20.5 mm impact socket for wheel nuts with missing chrome cap
- 21.5 mm impact socket for wheel nuts with deformed chrome cap

12<sup>5</sup> 1/2"



2

2



V5933/3

EAN 4047728079624

1/2" impact socket set · extra long

- Damage-free operation of wheel bolts by rotating plastic sleeve
- Extra long design
- For impact operation



12<sup>5</sup> 1/2"



VIGOR No.		Length mm	Size mm	EAN 4047728+
V5930	12 <sup>5</sup> 1/2"	150	17	059305
V5931	12 <sup>5</sup> 1/2"	150	19	060318
V5932	12 <sup>5</sup> 1/2"	150	21	079617



V7001

EAN 4047728075060

Universal rim lock removal set

- Malleable rim keys for loosening almost all rim locks
- Also for rim locks with clover leaf profile, among others
- Malleable rim keys adapt to the profile by hammer strike
- Rim keys can be used on both sides
- After forming a rim key, all four rim locks of a vehicle can be released
- Multiple deformation of a key side not possible

Contents:

- 8 rim keys
- 2 adapters
- Socket 1/2" - size 24 mm
- Impact body
- Centring pin
- Hand guard trim



Take a look!



1/2" TORQUE WRENCH

- Torque release: palpable and audible
- Release accuracy tolerance ± 4% of the scale value (in direction of actuation)
- With serial number and certificate
- DIN EN ISO 6789-2:2017, DIN 3120, ISO 1174-1A

±4%

12<sup>5</sup> 1/2"



VIGOR No.	Nm		Length mm	Tolerance %	EAN 4047728+
V3898	20 - 120	12 <sup>5</sup> 1/2"	445	4	038980
V3441	40 - 200	12 <sup>5</sup> 1/2"	540	4	034418
V3899	60 - 320	12 <sup>5</sup> 1/2"	610	4	038997

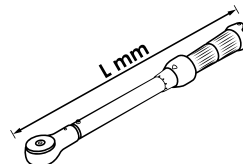

**V5505N**

EAN 4047728080484

**Impact universal joint set**

- Working in areas with restricted access, and for getting around obstructive edges

6.3 1/4" 10 3/8" 12.5 1/2"

6.3 1/4" 10 3/8" 12.5 1/2"



VIGOR No.	6.3 1/4"	10 3/8"	EAN 4047728+
<b>V5505N-1/4</b>	6.3 1/4"	6.3 1/4"	<b>083324</b>
<b>V5505N-3/8</b>	10 3/8"	10 3/8"	<b>083317</b>
<b>V5505N-1/2</b>	12.5 1/2"	12.5 1/2"	<b>083300</b>

**AIR BLOW GUNS**

- Fast cleaning and removal of chips and other foreign objects
- Long-life aluminium housing
- Suspension device incorporated



VIGOR No.	Design	EAN 4047728+
<b>V7135</b>	short	<b>071352</b>
<b>V7135-150</b>	long · tip 150 mm	<b>071369</b>

**V5672**

EAN 4047728056724

**Die grinder · straight design**

- Cutter, cutting wheels, grinding pads with 3 and 6 mm collet chuck
- 22000 rpm
- 350 watt
- 128.2 l/min

**SPEED GIANT**

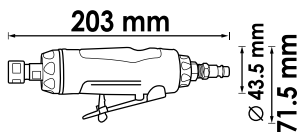

**V5673**

EAN 4047728056731

**Die grinder · angled**

- Cutter, cutting wheels, grinding pads with 3 and 6 mm collet chuck
- 20000 rpm
- 250 watt
- 85.5 l/min

**SPEED GIANT**

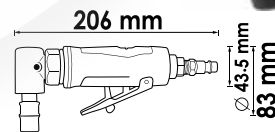

**V5674**

EAN 4047728056748

**Air ratchet**

- For areas with restricted access
- Reversing switch on ratchet head
- 240 rpm
- 35.2 Nm
- 77 l/min

**QUICK GIANT** 6.3 1/4"

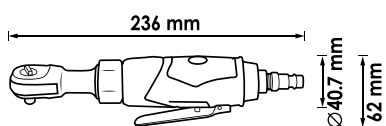

**V6554**

EAN 4047728065542

**Air ratchet**

- For areas with restricted access
- Reversing switch on ratchet head
- 240 rpm
- 35.2 Nm
- 77 l/min

**QUICK GIANT** 10 3/8"

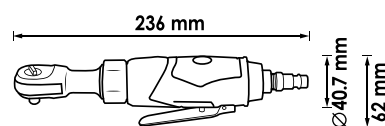



**V5671N**

EAN 4047728076715

**MINI GIANT**

1/2" impact wrench · mini



Size comparison between V5671N & V4800N

12<sup>5</sup> 1/2"

**1/2"**  
**1200 Nm**

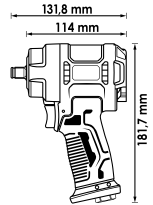

Ø mm	Nm	max. Nm	max. Nm	rpm	kg	l/min.	bar	m/s <sup>2</sup>
12,91(16) 17,2	600	850	1200	10000	1.28	141.5	6.3	6.81



**V4800N**

EAN 4047728075633

**ECO GIANT**

1/2" impact wrench



12<sup>5</sup> 1/2"

**1/2"**  
**1720 Nm**

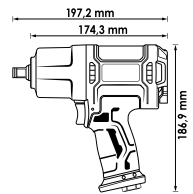

Ø mm	Nm	max. Nm	max. Nm	rpm	kg	l/min.	bar	m/s <sup>2</sup>
12,91(16) 17,2	850	1100	1720	7000	2.30	198.1	6.3	6.47

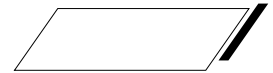

**V6899N**

EAN 4047728076944

**GIGA GIANT**

3/4" impact wrench



20 3/4"

*The most powerful in its class!*

**3/4"**  
**2300 Nm**

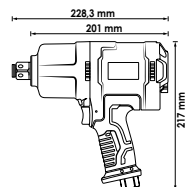

Ø mm	Nm	max. Nm	max. Nm	rpm	kg	l/min.	bar	m/s <sup>2</sup>
16,41(16) 17,2	1400	2000	2300	5500	3.60	254.8	6.3	5.75



# Video borescope now also with Ø 3.9 mm probe!

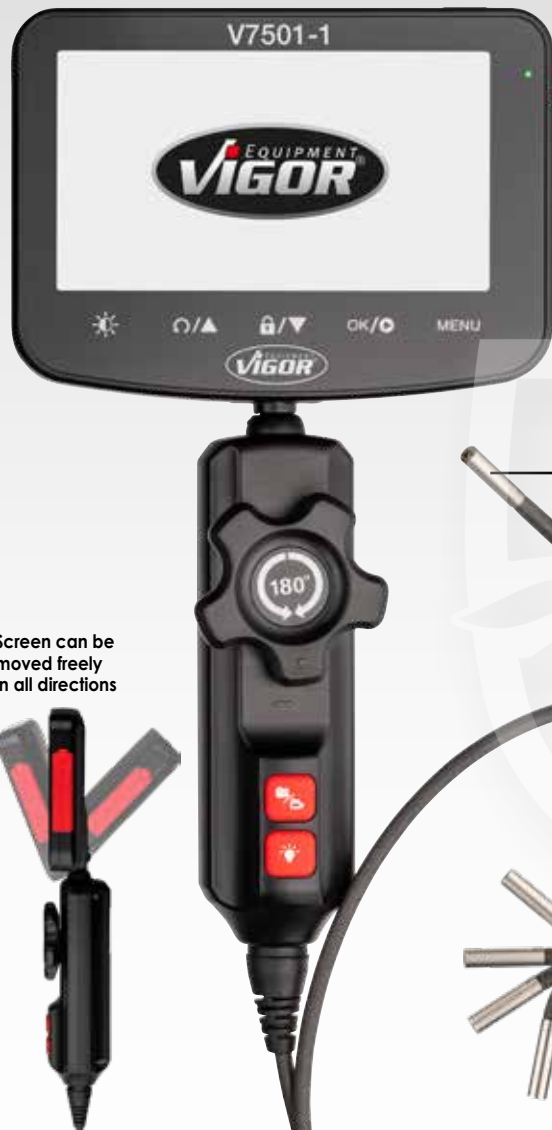

Screen can be moved freely in all directions



Swivels 180° on both sides



#### Analysis and documentation of damage patterns in difficult to access spaces!

- Probe: Ø 3.9 mm or Ø 4.9 mm
- Probe length: 1000 mm
- Camera resolution: 1280 x 720 (corresponds to HD quality)
- Camera viewing angle: 80°
- 6 dimmable LEDs
- Depth of field: 20 – 80 mm
- 5" display, swivelling
- Display resolution: 1280 x 720 pixels
- 6 Ah, 3.7 V Li-ion rechargeable battery
- 2A/5V power supply unit, USB charging cable and 32 GB TF memory card included in delivery



### Comparison

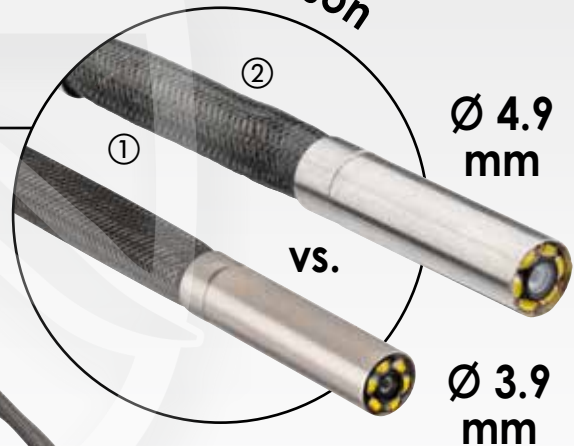

VS.



	VIGOR No.	Designation	Ø mm	EAN 4047728+
①	<b>V7501-39</b>	Video borescope with probe	3.9	<b>082037</b>
②	<b>V7501/2</b>	Video borescope with probe	4.9	<b>080255</b>



Your VIGOR specialist dealer:



VIGOR GmbH · Am Langen Siepen 13–15 · 42857 Remscheid · GERMANY  
www.vigor-equipment.com · info@vigor-equipment.com

EINFACH VIGOR.



V7026N-2

EAN 4047728085656

New

UNIVERSALO 2  
Specialty tool assortment

## UNIVERSALO 2



V7201N



### Compact wheel bearing removal / installation set

- For removing and installing compact wheel bearings with or without circlip
- Adjustability enables use on all types of currently available and future compact wheel bearings



V2846

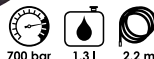

### Pneumatic foot pump

- Design with manometer
- For all hydraulic cylinders
- Working pressure: 700 bar
- Hose length: 2.2 m
- Oil tank: 1.3 l



V4906N-1



### Standard wheel bearing removal / installation set

- New effective method for removing wheel hubs; the use of wheel bearing set V4598 is recommended here. The set also functions with steering knuckles with uneven and limited surfaces
- Mounting washers with a diameter of 62 – 83 mm and support discs of 34 – 60 mm are included; the bearing shell is suitable for wheel bearings of up to 92 mm in diameter



V5549-1N



### Compact wheel bearing expansion set

- Set contains 4 extensions:
  1. Disassembly feet for bolted compact wheel bearings (3 bolts)
  2. Disassembly feet for bolted compact wheel bearings (4 bolts)
  3. Removal unit of the wheel hub without prior removal of the drive shaft
  4. Removal unit of the screwed wheel bearing without prior removal of the drive shaft
- Especially for expanding and completing compact wheel bearing sets



V6395

Including container for storing the pump

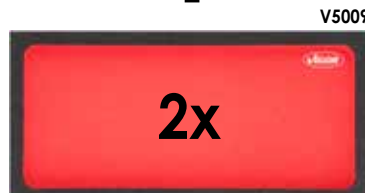

V5009

2x



V4904



### Set of devices for the removal of drive shafts

- For passenger cars with T4 and 5-hole wheel hubs due to oval holes for wheel bolts
- Avoids damage to the drive shaft and surrounding parts, as heating is no longer necessary



V7071



UPDATE

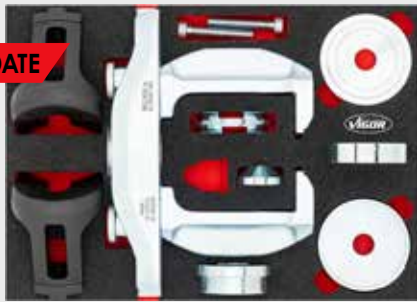

V7201N

### Compact wheel bearing removal / installation set

- For removing and installing compact wheel bearings with or without circlip
- Adjustability enables use on all types of currently available and future compact wheel bearings

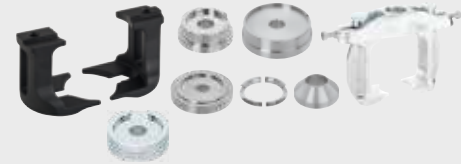

UNIVE



Installation



Removal



UPDATE



V4906N-1

### Standard wheel bearing removal / installation set

- New effective method for removing wheel hubs; the use of wheel bearing set V4598 is recommended here. The set also functions with steering knuckles with uneven and limited surfaces
- Allows the wheel bearings to be changed directly on the vehicle with minimum effort
- Mounting washers with a diameter of 62 – 83 mm and support discs of 34 – 60 mm are included; the bearing shell is suitable for wheel bearings of up to 92 mm in diameter



### Compact wheel bearing expansion set

- Set contains 4 expansions:
  1. Disassembly feet for screwed compact wheel bearings (3 bolts)
  2. Disassembly feet for screwed compact wheel bearings (4 bolts)
  3. Disassembly unit of the wheel hub without prior removal of the drive shaft
  4. Disassembly unit of the screwed wheel bearing without prior removal of the drive shaft
- Especially for expanding and completing compact wheel bearing sets
- When combined with the base unit V4680, all commercially available compact wheel bearings can be removed / installed



V5549-1N



Screwed wheel bearing units – 3 bolts



Screwed wheel bearing units – 4 bolts



Removal of the wheel hub without removing the drive shaft



Removal of the wheel bearing without removing the drive shaft

UPDATE



V7722N

### Press frame expansion set

- Set contains:
  - 14 t compressive hydraulic cylinder including thrust rod M 24
  - Support set 275 mm
  - Open plate including screw M 16 x 40 mm



V7723

### Drawbar expansion set

- Universal expansion for 18 t and 22 t hydraulic cylinder
- Spindle set makes it possible to remove and insert even more bushings and bearings with various inside diameters
- Set contains:
  - Adapter: M 22 – M 10 · M 22 – M 12 · M 22 – M 14 · M 18 – M 22
  - 4 drawbars including flange nuts: M 10 x 1.5 · M 12 x 1.75 · M 14 x 2.0 · M 20 x 2.5
  - Striker nut M 18





## UNIVERSALO 1



V5741N

### Rear axle longitudinal control arm · silent block FORD, MAZDA, Volvo

- For changing the bushing of the front longitudinal strut in the rear area and for changing the rear axle bushings
- Bushing and press frame can withstand loads of up to 22 tonnes



V7030-2

EAN 4047728077323

### UNIVERSALO 1 Specialty tool assortment



### Pressure sleeve set

- Including 24 pressure pieces of different sizes
- Sleeves with small diameters are reversible
- Adapter and pressure shaft enable application of the press frame V2885–useful when removing or installing bushings and supporting joints without holes

» **UPDATE: now even more fields of application!**



V5066



V2846



V6395

Incl. container for storing the pump.



### Pneumatic foot pump

- Design with manometer
- For all hydraulic cylinders
- Working pressure: 700 bar
- Hose length: 2.2 m
- Oil tank: 1.3 l



V7724

### Ball joint ejector

- Set for universal removal of ball joints with 4.5 t compressive force
- Contains hydraulic unit V5916 and expansions V5916-1 and V5916-2
- V5916-1: Pressing out ball joints as well as steering tie rod ends, with bolts instead of nut threaded connections on the cone axis
- V5916-2: For ball joint pins with a length over 72 mm



V5916

### Set of devices for the removal of drive shafts

- For passenger cars with T4 and 5-hole wheel hubs due to oval holes for wheel bolts
- Avoids damage to the drive shaft and surrounding parts, as heating is no longer necessary



V4904



V4680

EAN 4047728046800

## Compact wheel bearing removal / installation set

- For removing and installing compact wheel bearings with or without circlip
- Use with hydraulic cylinder, mechanical spindle or workshop press
- Max. load: 22 t
- Pump not included in delivery
- For e.g.:
  - **VOLKSWAGEN:** Polo, Lupo, Touareg, Fox, T5 front and rear, Crafter
  - **AUDI:** A2
  - **SEAT:** Ibiza, Córdoba
  - **ŠKODA:** Fabia, Rapid, Roomster
  - **FORD:** Focus, C-Max, Mondeo, S-Max, Kuga, etc.

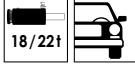

## Basic set



For removal

For installation

### Compact wheel bearing

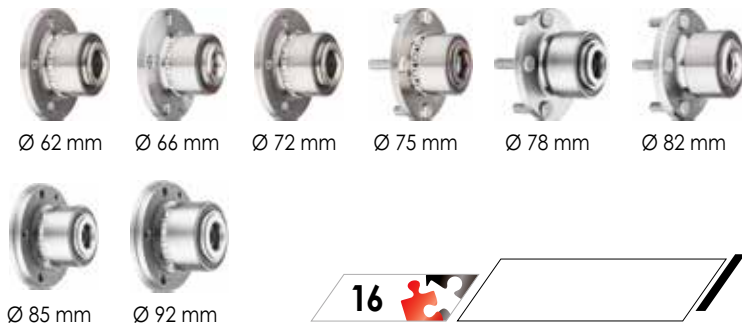

16

V5554

EAN 4047728055543

## Expansion set 1

- Hydraulic foot pump V2847 and pressure and tension cylinder 22 t V2854 also included in set V4680

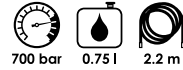

- Non-drip quick coupling
- For all hydraulic cylinders



V5554-2

EAN 4047728069021

## Expansion set 2

- Pneumatic foot pump V2846 and pressure and tension cylinder 22 t V2854 also included in set V4680



- Design with manometer
- Non-drip quick coupling
- For all hydraulic cylinders



**V5168**

EAN 4047728051682

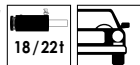

### Set of devices for the removal of drive shafts

- Especially suitable for removing rusted and glued drive shafts on the vehicle
- Suitable for all passenger cars with 4 and 5-hole wheel hubs due to oval holes for wheel bolts
- Avoids damage to the drive shaft and surrounding parts, as heating is no longer necessary
- Application: Bolt the hub to the wheel bolts of the vehicle, press out the drive shaft with an 18 t or 22 t hydraulic cylinder



## Basic set



12



**V5168-2**

EAN 4047728085618

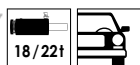

### Expansion set

- Pneumatic foot pump V2846 additionally included in set V5168



+



V2846

15



**V8562**

EAN 4047728085625



## Rear axle bushing set FORD Explorer

- Time-saving application directly on the vehicle, as the rear axle differential does not have to be completely removed
- Compatible with model years from 2020: Regardless of whether the vehicle has one or two bushes on the rear axle, the tool fits both models and bushings.
- Efficient pull function: Thanks to the M14 drawbar, no pre-drilling is necessary, even if stronger drawbars need to be used.
- Recommended accessories: cylinder 18 tonnes – V4551

**New**



6

**V8563**

EAN 4047728085632



## Pressure foot extension set · 30 mm

- Pressure foot extension set optimises work processes. Specially developed for mounting plate V3871.
- Increased reach: Extends the pressure feet by 30 mm, allowing access to hard-to-reach bearings.
- Perfectly suited for bearings with an extra-long guide or raised bearing housing
- Maximum flexibility: Compatible with all pressure feet, it offers a versatile solution for a wide range of requirements.

**New**



4

**V8366**

EAN 4047728083669

## Specialty tool extension

- Specialty tool set as an ideal extension to the V7026 and V7030 chassis assortments
- Useful extensions for centring compact wheel bearings during installation
- Universal pressure sleeves with outer diameters from 28.6 to 44.7 mm
- Cylinder holder for convenient working with the hydraulic system

**XL**

**2 K**



40



**V8327**

EAN 4047728083270



## Axle shaft removal set · gearbox side

- Powerful, efficient removal tool for outer homocinetic joint
- Prevents pulling, hammering and damage to the spherical joint bearing
- Contains 5 kg sliding hammer and strong axle support with chain tensioner
- Enables removal directly on the vehicle
- Secures the joint in the puller to prevent accidents and dirt
- Sliding hammer V2922 M18 x 2.5

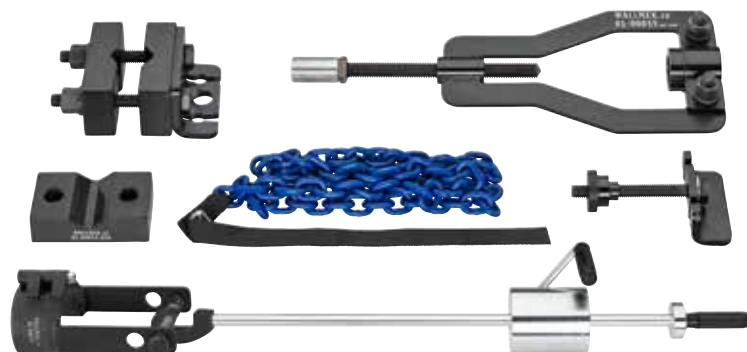

5

**V8327-1**

EAN 4047728083287



## Axle shaft puller, outer joint

- Extension for removal of the homocinetic joint
- Additional sliding hammer V2922 is required
- Socket M18 x 2.5

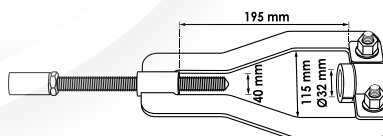
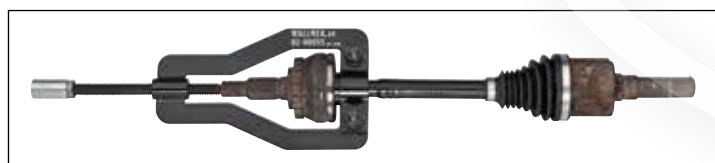

**V7862**

EAN 4047728078627



## Axle shaft removal set

- Removal of the inner axle shaft from the gearbox unit
- Full gripping of the axle shaft prevents damage caused by hammering or pulling
- Variable settings of the axle shaft holder allow optimum access to the shaft
- Depending on the installation situation, the holder can be disassembled into two parts and clamped around the axle shaft
- Universally adjustable holder allows use from small cars to commercial vehicles
- Use with 5 kg sliding hammer V2922

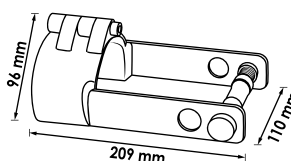
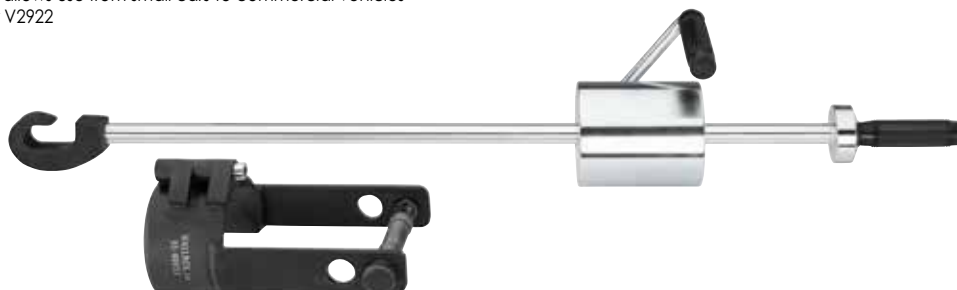

3

**Hydraulic spring vice**

- Can be used for almost any strut and shock absorber in passenger cars as well as lightweight vans
- By gripping the springs within the spring windings any possible awkward parts on the shock absorber are irrelevant and have no influence on the operation of the spring vice
- Tripod with included rollers enables stowing and mobile work with the spring vice



**Take a look!**



**A safety tool with technical sophistication!**

**2.1t**

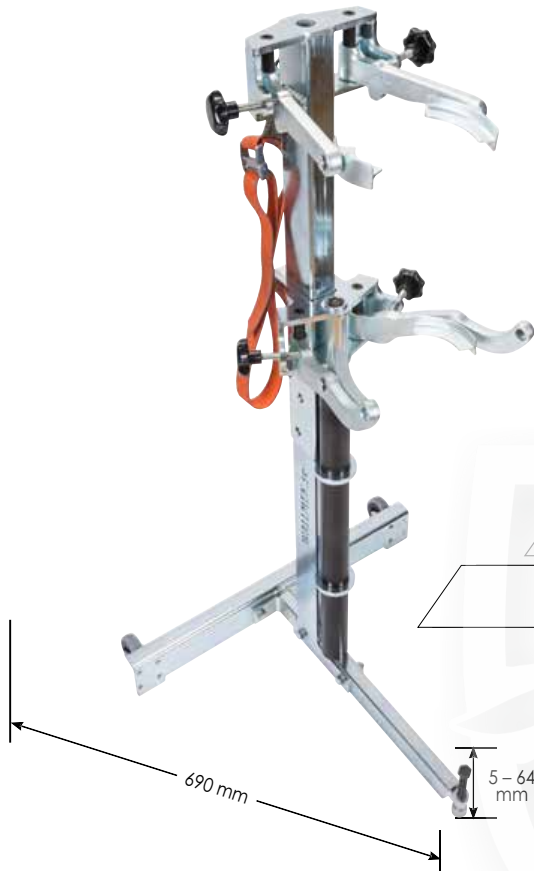

**V4476N/2**

EAN 4047728084512

**Expansion set**

- Hydraulic spring compressor V4476N including hydraulic foot pump V2847

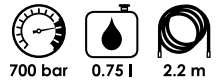

- Non-drip quick coupling
- For all hydraulic cylinders



**Including 10 spring plates**

Ø 70 – 160 mm



Ø 150 – 240 mm

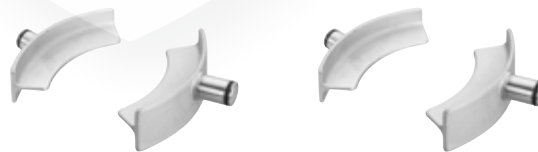

Ø 150 – 240 mm



**① Pre-tensioning the spring**



**② Tensioning the spring**



**③ Support device**

